

ATGET®

304 STAINLESS STEEL BATH ACCESSORIES

Collection 2026

COMMERCIAL | RESIDENTIAL
PUBLIC | HANDICAP
WASHROOM

INDEX

ATGET®

Brand	1
Paper Towel Dispenser With Waste Receptable Bin	3
Paper Holder	4
Paper Towel Dispenser	5
Soap Dispenser	7
Bathroom Basket	8
Towel Bar	10
Ø32mm Grab Bar	10
Ø25mm Grab Bar	11
Disable Support Rail	12
Towel Shelf	13
Ø38mm Grab Bar	13
AX28 Series	15
Floor Drainer	17
Soap Dish & Ash Trays	19
Toilet Brush Holder	19
Hook	19
Clothes Line	19
Stainless Steel Finishes	20

ATGET® is a professional brand specialized in manufacturing sanitary hardware products.

ATGET established since 1994 and have focused on designing and manufacturing sanitary hardware/ fitting products expertized by using 304 stainless steel (SUS 304) and subjected to the material basis, it has developed plenty of products which are matched and just right to the washroom needs for Hotels, Commercial Buildings, Residentials, Academics & etc.,



MATERIALS

The selection of materials started from your needs, emphasizing cost-effective for individual material, not to sacrifice quality for the concession of price and also considering the price equilibrium among the materials, ensure each selection of materials is constituted a full set of high quality product's necessarily choice and application, and durable.

QUALITY

Every piece of product will be contracted with your home, and eventually become one of your most important lof life. Therefore, at the beginning stage of production, we have the quality as the standard for materials, and workmanship.

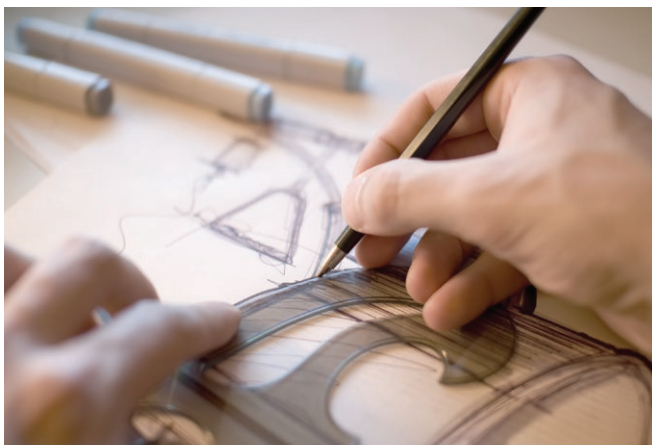

DESIGN

In the ATGET products world, design is getting through every detail, every where filled with the aesthetic feeling by the combination of art and life. At the elegant mood brought by ATGET, are all studying and understanding of the poetry life experience, to perfect combine together with the aesthetic realm and industry technology. Design is in everywhere.

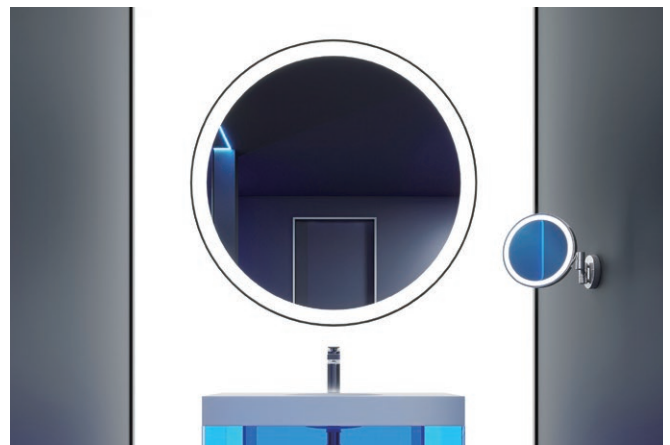

HUMANITY

The essence of industrial design, is entirely appropriated the human behavior space, only truth up to a high desgree of integration of people and objects, allowed people to enjoy great freedom in the space, thus achieved the full care for the peoples. The concept of people-oriented integrated with personallity design, and spiritual background, are all reflected the persist pursuit of ATGET about humanity consideration.

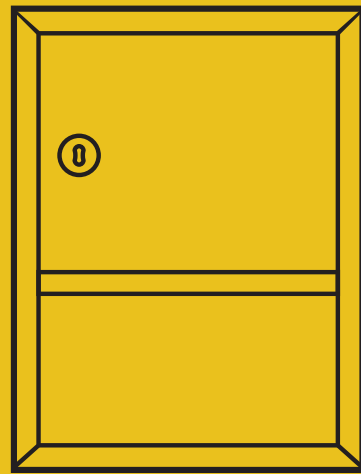

•
enviroment

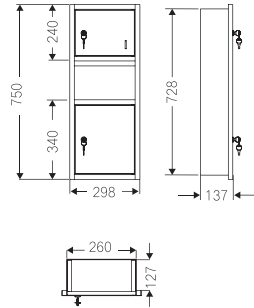

TD-8332S

Paper Towel Dispenser with Waste Receptacle Bin
 • Recessed Wall Mounting
 Dimension: W300 x D137 x H750mm
 Finishing : Satin

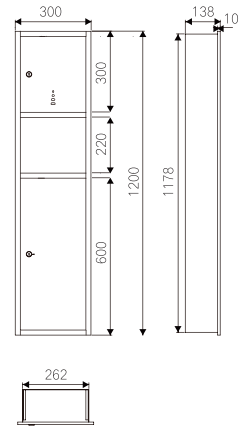

TD-8334S-1200

Paper Towel Dispenser with Waste Receptacle Bin
 • Recessed Floor Mounting
 Dimension: W300 x D138 x H1200mm
 Finishing : Satin



TD-8334S

Paper Towel Dispenser with Waste Receptacle Bin
 • Recessed Floor Mounting
 Dimension: W300 x D137 x H1400mm
 Finishing : Satin

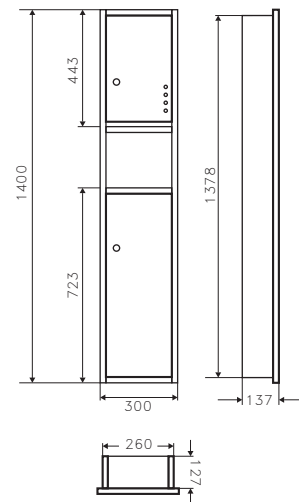

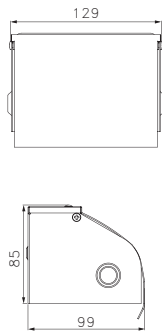

TD-131A

Paper Holder with Hood
Dimension : W129 x L99 x H85mm
Finishing : Polish

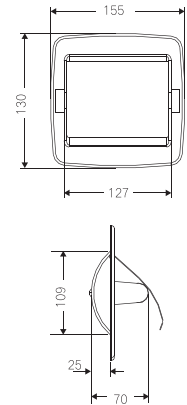

TD-231A

Semi-Recessed Paper Holder with Hood
Dimension : W155 x L70 x H130mm
Finishing : Polish

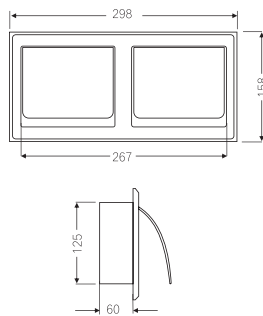

TD-2332W

Recessed Twin Paper Holder with Hood
Dimension : W298 x L60 x H158mm
Finishing : Polish

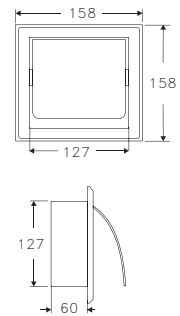

TD-233

Recessed Paper Holder with Hood
Dimension : W158 x L60 x H158mm
Finishing : Polish

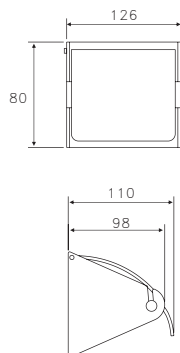

TD-2371A

Paper Holder with Hood
Dimension : W126 x L110 x H80mm
Finishing : Polish

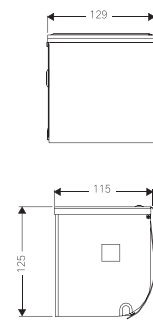

TD-333A

Paper Holder with Hood
Dimension : W129 x L115 x H125mm
Finishing : Polish

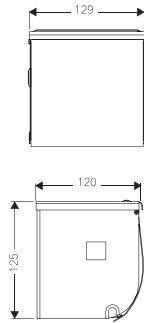

TD-333D

Paper Holder with Hood
 Dimension : W129 x L120 x H125mm
 Finishing : Polish

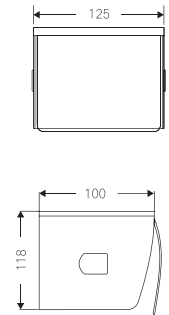

TD-8305D-2

Paper Holder with Hood
 Dimension : W125 x L100 x H118mm
 Finishing : Polish

ATGET. PAPER TOWEL DISPENSER

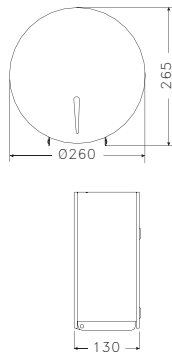

TD-8300A

Jumbo Toilet Roll Holder
 Dimension : Ø260 x L130mm
 Finishing : Satin

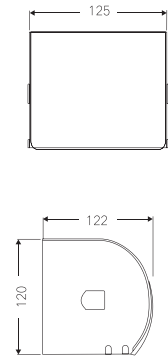

TD-83A6

Paper Holder with Hood
 Dimension : W125 x L122 x H120mm
 Finishing : Polish

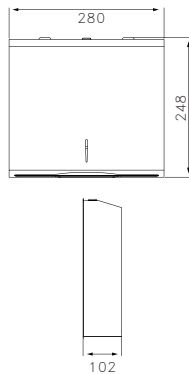

TD-8313A

Paper Towel Dispenser
 Dimension : W280 x L102 x H248mm
 Finishing : Satin

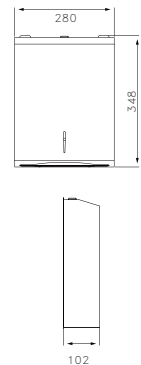

TD-8314A

Paper Towel Dispenser
 Dimension : W280 x L102 x H348mm
 Finishing : Satin

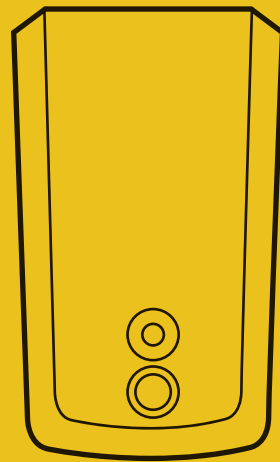

hygiene

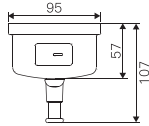
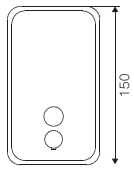

SD-380P

500ml Soap Dispenser
 Dimension: W95 x L107 x H150mm
 Finishing : Polish

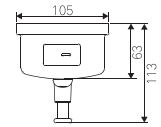
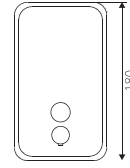

SD-680P

850ml Soap Dispenser
 Dimension: W105 x L113 x H180mm
 Finishing : Polish

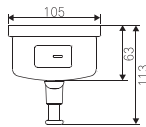
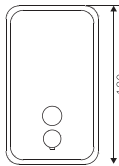

SD-680H

850ml Soap Dispenser
 Dimension: W105 x L113 x H180mm
 Finishing : Satin

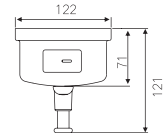
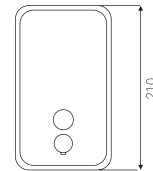

SD-1080H

1250ml Soap Dispenser
 Dimension: W122 x L121 x H210mm
 Finishing : Satin

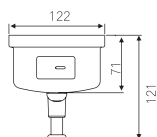
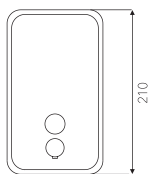

SD-1080P

1250ml Soap Dispenser
 Dimension: W122 x L121 x H210mm
 Finishing : Polish

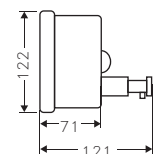
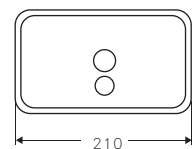

SD-1080W

1250ml Soap Dispenser
 Dimension: W210 x L121 x H122mm
 Finishing : Polish

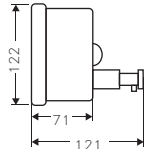
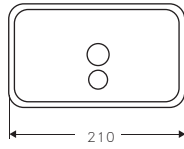

SD-1080WH

1250ml Soap Dispenser
Dimension: W210 x L121 x H122mm
Finishing : Satin

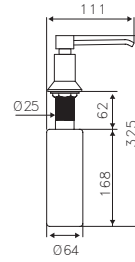

SD-W350

350ml Lavatory-Mounted Soap Dispenser
Dimension: 144 x 280 x 48mmmm
Finishing : Polish

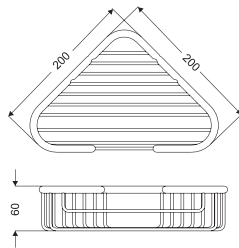

SB-034SS

Corner Basket
Dimension: L200 x W200 x H60mm
Finishing : Satin

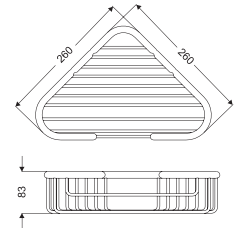

SB-170SS

Corner Basket
Dimension: L260 x W260 x H83mm
Finishing : Satin



trustworthy



specialty

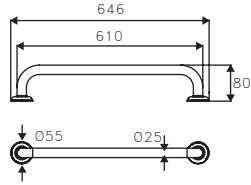

ANH-401-19-610

24" Towel Bar
Dimension: L610 x W83 x Ø25mm
Finishing : Polish

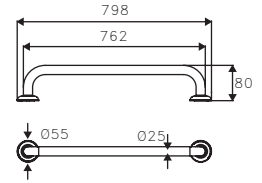

ANH-401-19-762

30" Towel Bar
Dimension: L762 x W83 x Ø25mm
Finishing : Polish

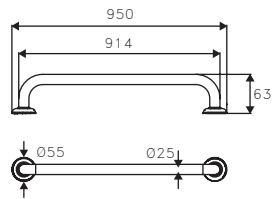

ANH-401-19-914

36" Towel Bar
Dimension: L914 x W83 x Ø25mm
Finishing : Polish

Ø32mm GRAB BAR ATGET.

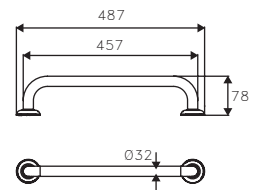

ANH-501-32-457S

457xØ32mm Grab Rail
Dimension: L457 x W78 x Ø32mm
Finishing : Satin

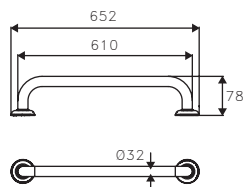

ANH-501-32-610S

610xØ32mm Grab Rail
Dimension: L610 x W78 x Ø32mm
Finishing : Satin

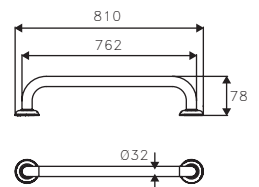

ANH-501-32-762S

762xØ32mm Grab Rail Satin
Dimension: L762 x W78 x Ø32mm
Finishing : Satin

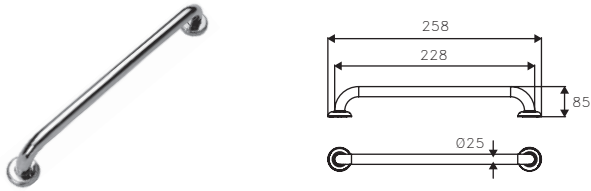

ANH-401-25-228

228mm Grab Bar
 Dimension: L228 x W85 x Ø25mm
 Finishing : Polish

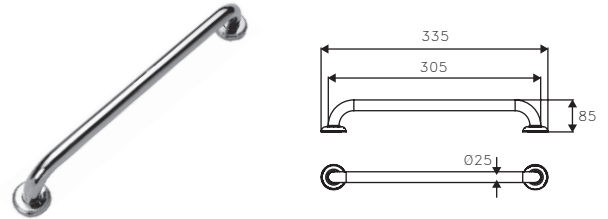

ANH-401-25-305

305mm Grab Bar
 Dimension: L305 x W85 x Ø25mm
 Finishing : Polish

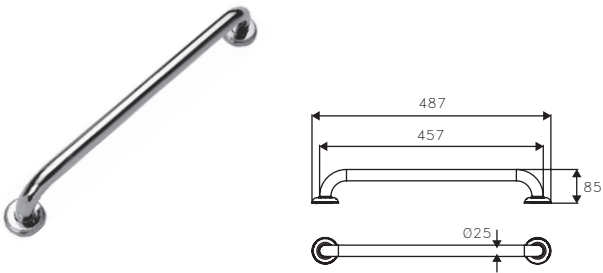

ANH-401-25-457

457mm Grab Bar
 Dimension: L457 x W85 x Ø25mm
 Finishing : Polish

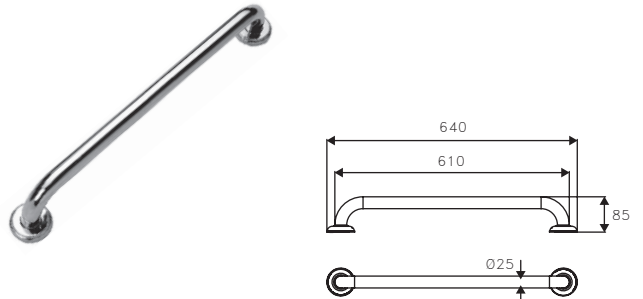

ANH-401-25-610

610mm Grab Bar
 Dimension: L610 x W85 x Ø25mm
 Finishing : Polish

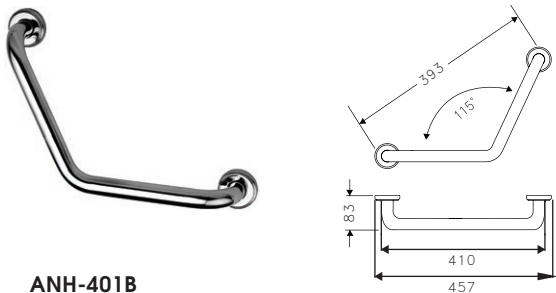

ANH-401B

457mm Angle Grab Bar
 Dimension: L410 x W83 x H210 x Ø25mm
 Finishing : Polish

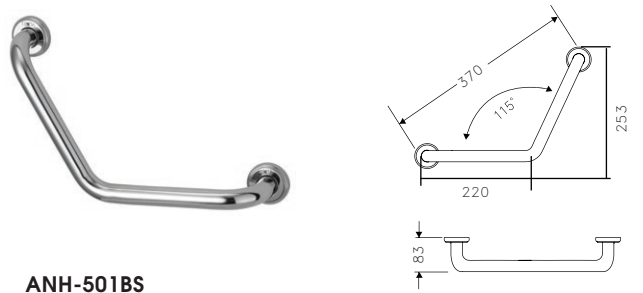

ANH-501BS

423mm Angle Grab Bar
 Dimension: L395 x W83 x H253 x Ø25mm
 Finishing : Satin

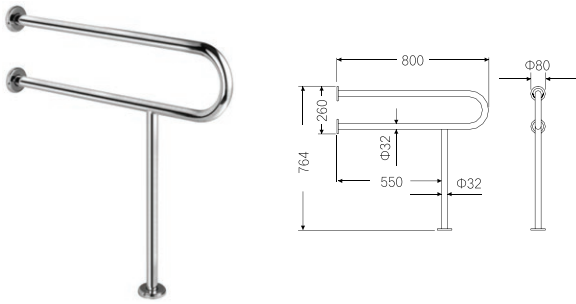

BNH-19010

U-Shape Support Rail
Dimension: L800 x H764 x Ø32mm
Finishing : Polish

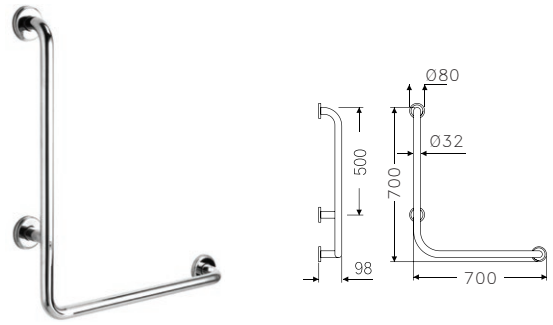

BNH-19020L

L-Shape Support Rail
Dimension: L700 x H700 x Ø32mm
Finishing : Polish

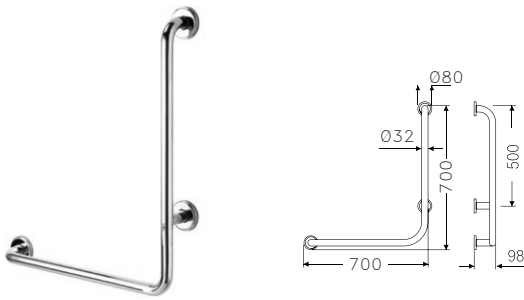

BNH-19020R

L-Shape Support Rail
Dimension: L700 x H700 x Ø32mm
Finishing : Polish

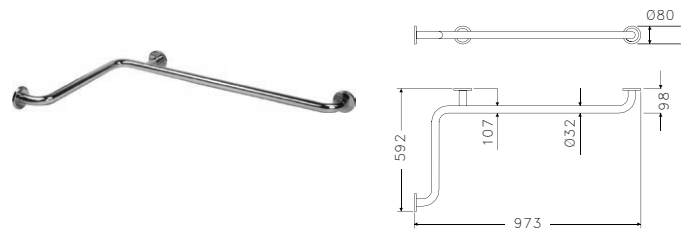

BNH-19022

L-Shape Support Rail
Dimension: 973 x 592 x Ø32mm
Finishing : Polish



BNH-19023

L-Shape Support Rail
Dimension: 1456 x 1030 x Ø32mm
Finishing : Polish

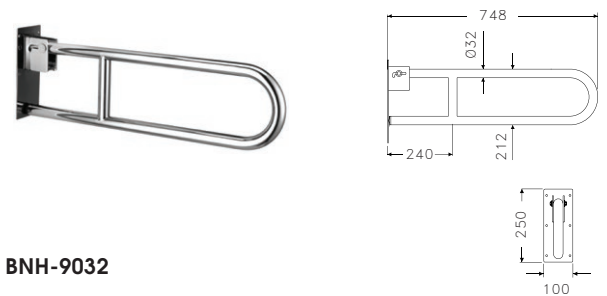

BNH-9032

Swing-up Support Rail
Dimension: L748 x H250 x Ø32mm
Finishing : Polish

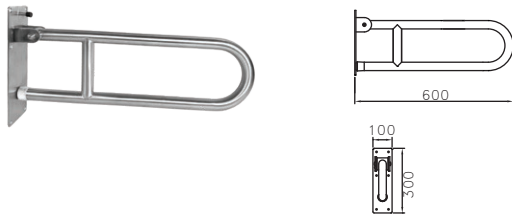

BNH-9036-600S

Swing-up Support Rail
 Dimension: L600 x H300 x 100mm
 Finishing : Satin



BNH-9036-750S

Swing-up Support Rail
 Dimension: L750 x H300 x 100mm
 Finishing : Satin

ATGET. TOWEL SHELF

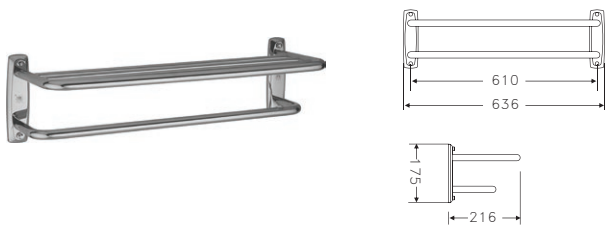

ANT-101-610

Towel Shelf with Rail
 Dimension: L610 x W216 x H175mm
 Finishing : Polish

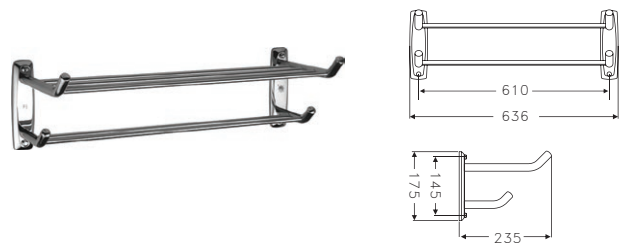

ANT-108-610

Towel Shelf with Rail
 Dimension: L610 x W235 x H175mm
 Finishing : Polish

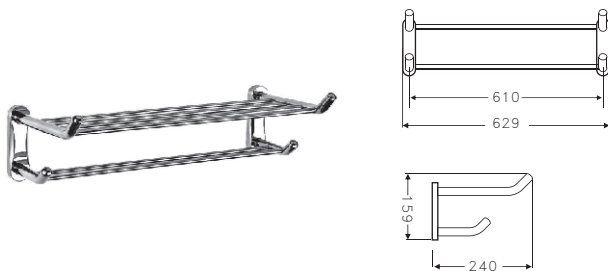

BNT-008-610

Towel Shelf with Rail
 Dimension: L610 x W240 x H159mm
 Finishing : Polish

ATGET. Ø38mm GRAB BAR

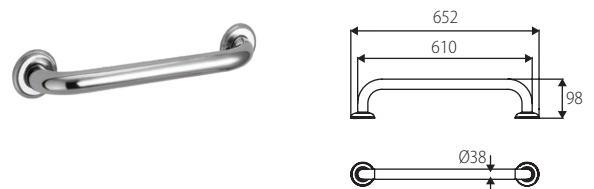

ANH-501

610 x Ø38mm Grab Rail
 Dimension: L610 x W98 x Ø38mm
 Finishing : Polish

perseverance

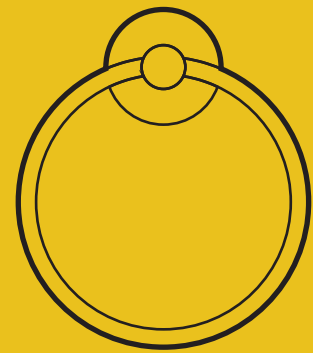

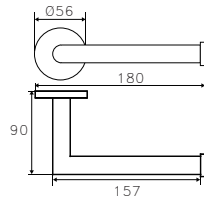

AX28-301P

Paper Holder
Dimension: L157 x W90 x H56mm
Finishing : Polish

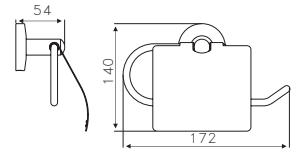

AX28-3011P

Paper Holder
Dimension: L140 x W172 x H54mm
Finishing : Polish

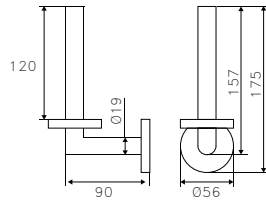

AX28-373P

Spare Roll Holder
Dimension: L56 x W90 x H157mm
Finishing : Polish

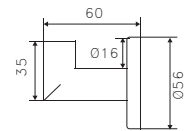

AX28-701P

Robe Hook
Dimension: L60 x W56 x H56mm
Finishing : Polish

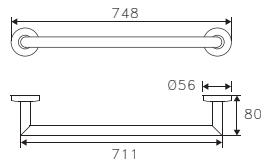

AX28-271P

71cm Single Towel Rail
Dimension: L711 x W80 x H56mm
Finishing : Polish

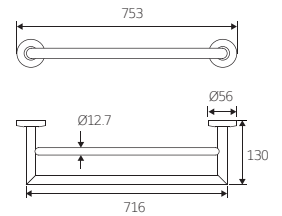

AX28-272P

71cm Double Towel Rail
Dimension: L716 x W130 x H56mm
Finishing : Polish

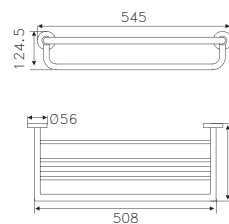

AX28-652P

Towel Shelf with Rail
Dimension: L508 x W245 x H125mm
Finishing : Polish

anchor hold



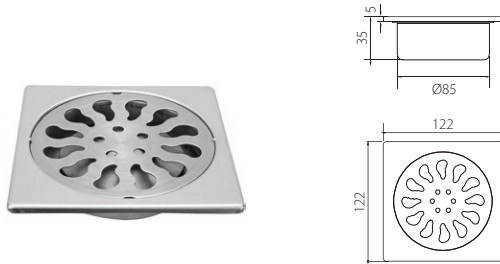

PD-31283

122 x 122mm Floor Drainer
 Dimension: L122 x W122 x H35mm
 Finishing : Satin

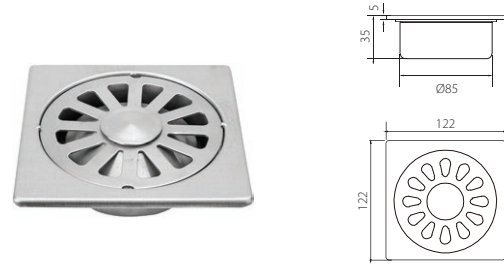

PD-3129

122 x 122mm Floor Drainer
 Dimension: L122 x W122 x H35mm
 Finishing : Satin

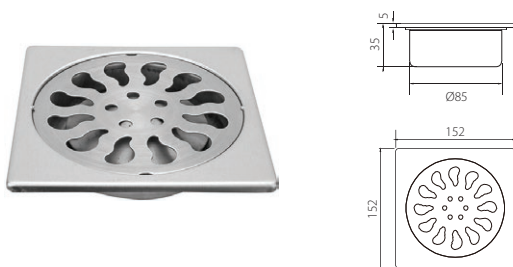

PD-31383

152 x 152mm Floor Drainer
 Dimension: L152 x W152 x H35mm
 Finishing : Satin



PD-31483

152 x 152mm Floor Drainer
 Dimension: L152 x W152 x H35mm
 Finishing : Satin

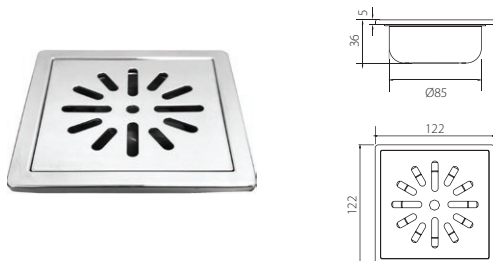

PD-31733P

122 x 122mm Floor Drainer
 Dimension: L122 x W122 x H36mm
 Finishing : Polish



PD-31743

122 x 122mm Floor Drainer
 Dimension: L122 x W122 x H36mm
 Finishing : Polish

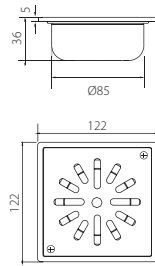

PD-31753P

122 x 122mm Floor Drainer
Dimension: L122 x 122 x 36mm
Finishing : Polish

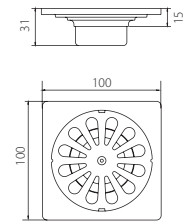

PD-3378S

100 x 100mm Floor Drainer
Dimension: L100 x W100 x H31mm
Finishing : Satin

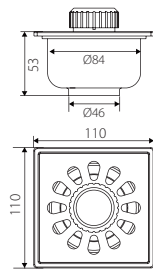

PD-3179A

110 x 110mm Floor Drainer
Dimension: L110 x 110 x 53mm
Finishing : Polish
Purpose : Washing Machine

FLOOR DRAINER "FOR WASHING MACHINE" **ATGET.**

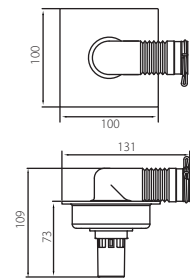

PD-3329

100 x 100mm Floor Drainer
Dimension: L100 x W100 x H73mm
Finishing : Polish
Purpose : Washing Machine

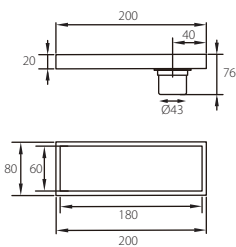

PD-3363A-20S

200 x 80mm Floor Drainer
Dimension: L200 x 80 x 76mm
Finishing : Satin

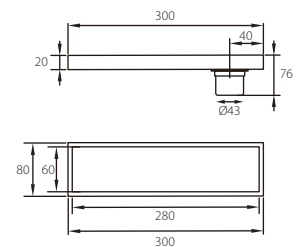

PD-3363A-30S

300 x 80mm Floor Drainer
Dimension: L300 x W80 x H76mm
Finishing : Satin

LINEAR FLOOR DRAINER **ATGET.**

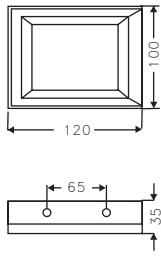

2303

Ashtray
Dimension: L120 x W35 x H100mm
Finishing : Polish

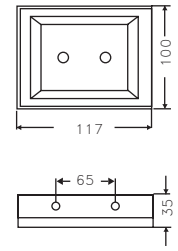

2304

Soap Dish
Dimension: L117 x W35 x H100mm
Finishing : Polish

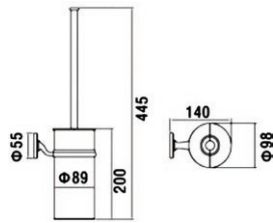

XT-5870

Wall Mounted Toilet Brush Holder
Finishing : Polish

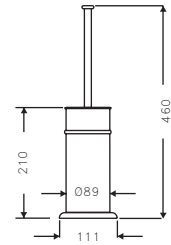

XT-8700

Toilet Brush Holder
Finishing : Polish

TOILET BRUSH HOLDER **ATGET.**

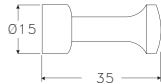

XT-707

Sanitary Bag Hook
Dimension: L35 x Ø15
Materials : Brass
Finishing : Chrome

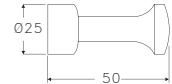

XT-708

Clothes Caps Hook
Dimension: L50 x Ø25
Materials : Brass
Finishing : Chrome

HOOK **ATGET.**

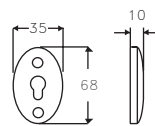
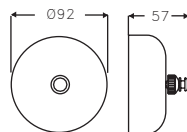
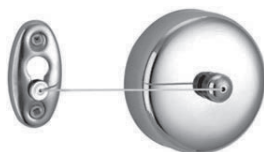

CL-4188A

Retractable Clothes Line
Dimension: L92 x W57 x H92mm
Finishing : Polish

CLOTHES LINE **ATGET.**



POLISH - A bright reflective finish which is achieved by bright buffing using a soft mop and suitable polishing compound. The process involved no pre-grinding and, as such, relies on the material having a good, defect-free surface. This type of finishing will not remove surface defects but is essentially an enhancement of the mill surface. This finish is generally more reflective than the bright annealed finish but the degree of brightness or reflectivity may vary according to application or cost considerations.

SATIN - A fine finish with an attractive lustre and smooth texture. It is produced using fine abrasives and a special cutting compound, giving it a clean, smooth “wet” cut surface. The smooth surface ensures minimal entrapment of surface debris from polishing or in use, making it suitable for most applications, especially architectural and building materials uses. It is also easier to clean due to its long, shallow grain and less prone to staining in external or critical applications. The finer grain blends more easily after fabrications than coarser finishes which require more physical effort. The “wet” cut abrasive system ensures a high degree of consistency from sheet to sheet and grit size can be adjusted to maintain the correct levels of roughness and reflectivity. This finish has a pleasing appearance and is pleasant to the touch, making it suitable for a vast range of products or components.





We reserve the right to change the details such as specifications and design,
or continue / discontinue without prior notice.

www.abagno.com